



PioneerTM Balances
Instruction Manual

Balanzas PioneerTM
Manual de Instrucciones

Balances PioneerTM
Guide de l'utilisateur

Visit www.balances.com to see the full line of Ohaus Balances

Visit www.scaleman.com to see more Ohaus Digital Scale

1. INTRODUCTION

1.1 Safety Precautions

Please follow these safety precautions:

- Verify that the AC Adapter input voltage matches the local AC power supply.
- Use the balance only in dry locations.
- Do not operate the balance in hostile environments.
- Do not drop loads on the platform.
- Do not place the balance upside down on the platform or platform mounting cone.
- Service should be performed only by authorized personnel.

1.2 Controls

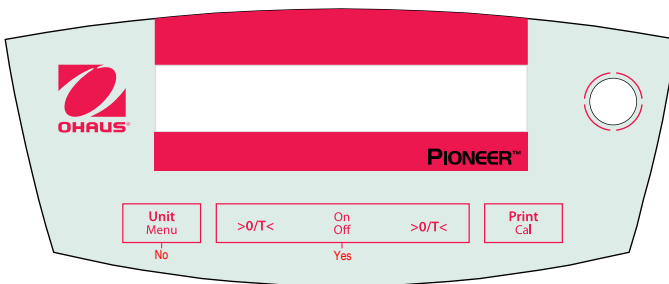

Button:	Functions:	
O/T - On	Short Press:	Turns balance on, sets display to zero
Off	Long Press:	Turns balance off
Yes	Short press (Menu):	Selects or accepts setting
Unit	Short Press:	Steps through active units and modes
Menu	Long Press:	Enters Menu
No	Short press (Menu):	Steps through available settings
	Long press (Menu):	Exit menu or abort out of menu item
Print	Short Press:	Sends data
Cal	Long Press:	Initiates Span Calibration

2. INSTALLATION

2.1 Package Contents

0.1g and 0.01g Models

- Instruction Manual
- Power Adapter
- Balance
- Pan
- Pan Support
- Wind-Ring (InCal models only)
- Warranty Card

0.001g and 0.0001g Models

- Instruction Manual
- Power Adapter
- Balance
- Pan
- Glass Doors and Panels
- Warranty Card

2.2 Install Components

0.1g and 0.01g Models

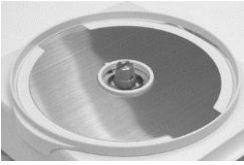

1) Install Wind-Ring (InCal only)



2) Install Pan Support



3) Install Pan

0.001g and 0.0001g Models

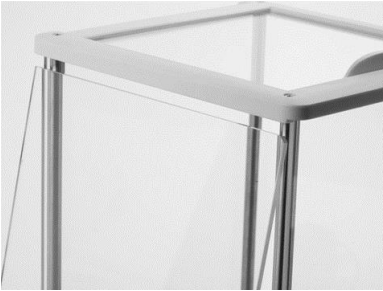

1) Install Side Doors - Insert fully into Top Frame then down over retainer.



2) Install Panels - Insert bottom edge in groove then press until locked.



3) Install Top Door



4) Install Pan

2.3 Level Balance

Level the balance on a firm, steady surface. Avoid locations with excessive air current, vibrations, heat sources or rapid temperature changes.

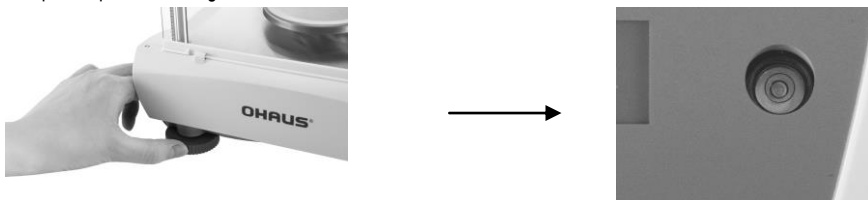

2.4 Connect Power

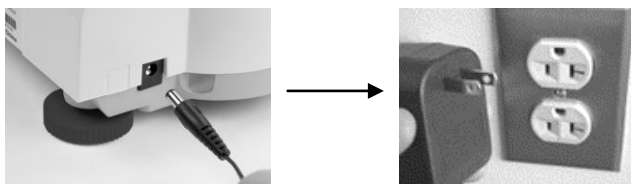

For use with CSA Certified (or equivalent approved) power source, which must have a limited circuit output.

2.5 Initial Calibration

Without InCal – Power on the balance by pressing **0/T**. Press and hold **Print/Cal** until [E_{RL}] is displayed. The display flashes the calibration mass needed. To select the alternate calibration weight press **No**. Put the calibration mass on the pan. The display flashes [b_{U5y}], then [L_{LR} P_{RN}]. Remove the mass. When calibration is complete, [d_{ONE}] is displayed.

InCal – Press and hold **Print/Cal** until [E_{RL}] is displayed. The display flashes [b_{U5y}], when calibration is complete, [d_{ONE}] is displayed.

Note: Calibrations should be performed after a warm up time of 60 minutes.

3. OPERATION

Count, APW Optimization, Percentage, Dynamic, Density or specific units of measure must be activated in the MODE or UNIT menus if they are not initially available.

3.1 Weighing Mode

Repeatedly press **Unit** until the desired unit icon is displayed.

Press **0/T** to zero the balance and then place objects to be weighed on the pan.

3.2 Count Mode – Use the Count mode to count parts of uniform weight.

To access Count Mode, press **Unit** until the display shows [C_{OUNT}].

Establish an Average Piece Weight (APW) – Each time a new type of part is to be counted, the nominal weight of one piece (APW) must be established using a small quantity of pieces.

With [L_{LR} P_{RN}] displayed, press **No** to use the previously saved APW, or press **Yes** to establish a new APW. The display indicates the number of pieces to be used to establish the new APW. If a different sample size is preferred, press **No** until the desired sample size is displayed (5, 10, 20, 50 or 100). Put the specified number of pieces on the pan. Press **Yes** to accept new APW or **No** to abort.

Count – Place the quantity to be counted on the pan.

APW Optimization – Since the weight of each piece varies slightly, APW Optimization may be used to increase the accuracy of the count. The balance automatically recalculates the Average Piece Weight when the number of parts on the pan is less than three times the original sample size. The display shows [RPLW.DP T] each time the APW is optimized.

3.3 Percent Mode – Use this mode to measure the weight of a sample as a percentage of a reference weight.

To access the Percent Mode, press **Unit** until the display shows [PERCENT].

Establish a new Reference Weight - With Clear reference [CLEAR REF] displayed, Press **No** to use the previously saved Reference Weight. Press **Yes** to establish a new Reference Weight. Put the reference sample on the pan and press Yes to accept or No to abort.

Percent – Place the object(s) to be compared to the reference weight on the pan.

3.4 Dynamic Mode – Use this mode to weigh an unstable load, such as a moving animal.

To access the Dynamic mode, press **Unit** until the display shows [DYNA].

Two different start/reset modes can be selected: Manual (start and stop via key press), Automatic (start and stop automatically).

The default Averaging Time is 5s.

After accessing this mode, the two “0/T” buttons will have different functions as shown in below picture.

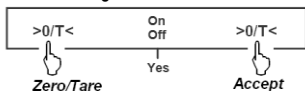

Set up Averaging Time-The default Averaging Time is 5s. The initial display shows [t 5].

The time “t5” is blinking. Press **No** to scroll the time selection 5, 10, 15, 20 and 30. The time unit is s (second).

Press the **right 0/T** button to select the desired option. After time is set, dynamic weighing will begin.

Begin Dynamic Manual mode-If there is no weight (less than 10d), the display shows [PLT] and [LWE .9HE] alternately. Place object(s) on weighing pan (more than 10d), the display shows the current weight value. Press the **left 0/T** button to zero or tare if needed. Press the **right 0/T** button to start the dynamic weighing. The count down is shown on the display, eg: “t 5”, “t 4”,... “t 1”. Once the averaging is finished, the result is displayed (blinking).

Press the **right 0/T** button to stop the blinking and go back to ready status.

Begin Dynamic Auto mode-If there is no weight (less than 10d), the display shows [PLT] and [LWE .9HE] alternately.

Place object(s) on weighing pan (more than 10d); the dynamic weighing will be started automatically. The count down is shown on the display, eg: “t 5”, “t 4”,... “t 1”. Once the averaging is finished, the result is displayed (blinking).

Remove the object(s), or press the **right 0/T** button, to clear the result and go back to ready status.

3.5 Density Mode -- Use this mode to determine an object’s density.

A density determination kit is needed to use this mode. For liquid density determination, one more sinker is needed.

To access the Density mode, press **Unit** until the display shows [DEN5 .t 5].

After accessing this mode, the two “0/T” buttons will have different functions as shown in below picture.

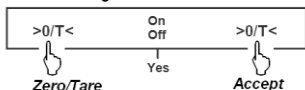

Begin Density Solid mode-The display shows [R .r] and [LWE .9HE] alternately. Place object(s) on the density determination kit (in the air), the display shows the weight value.

Press the **right 0/T** button to accept the weight as air weight.

The display shows [L .9w .d] and [LWE .9HE] alternately. Place object(s) on the density determination kit (in the liquid), please make sure that the entire object is submerged in the liquid, the display shows the weight value.

Press the **right 0/T** button to accept the weight as liquid weight. The density is calculated and result and [g/c] are shown alternately.

Press the **right 0/T** button to stop the blinking and go back to ready status.

Begin Density Liquid mode-The display shows [P r] and [LW ,gM] alternately. Place the sinker on the on density determination kit, the display shows the weight value.

Press the **right 0/T** button to accept the weight as air weight.

The display shows [L ,gM] and [LW ,gM] alternately. Place the sinker on the density determination kit (in the liquid), please make sure that the entire sinker is submerged in the liquid, the display shows the weight value.

Press the **right 0/T** button to accept the weight as liquid weight. The density is calculated and result and [g/c] are shown alternately.

Press the **right 0/T** button to stop the blinking and go back to ready status.

3.6 Weigh Below Feature



Remove Weigh Below Cover

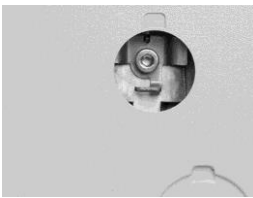

Attach wire or string to Hook

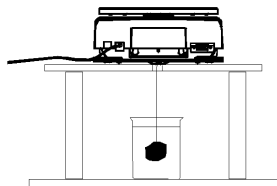

Suspend sample

4. SETTINGS

4.1 Menu Navigation

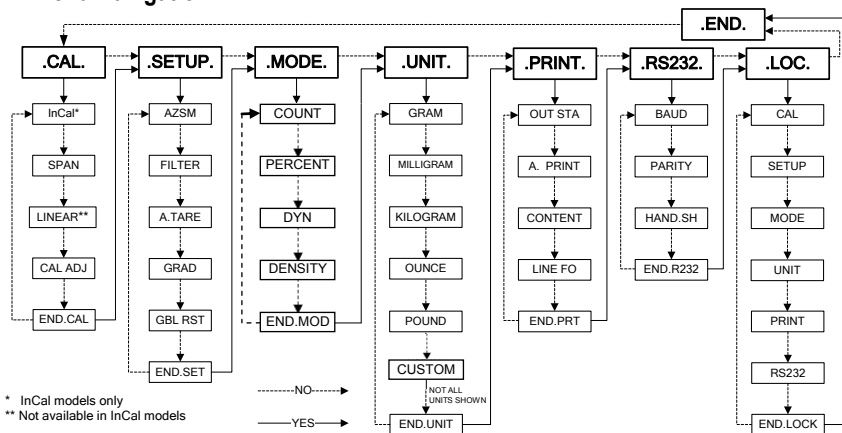

The mode menu has the following sub-menus:

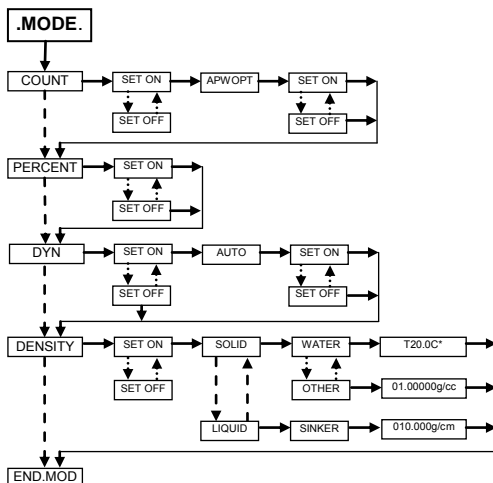

Note: * Use No key to change the temperature value

Enter Menu – When the balance is on, press and hold Unit/Menu until [F0E0] appears.

Release the button and the Calibrate [CAL.] menu will display.

Menu Navigation – Select menus, menu items and settings through use of the **Yes** and **No** buttons.

Solid arrows point to the content displayed when **Yes** is pressed, Dashed lines when **No** is pressed.

Changing Settings – To select the displayed Setting, press **Yes**. To move to the next Setting, press **No**.

Exit Menu – When [END.] is displayed, press **Yes** to exit the menu function, or press **No** to return to the Cal menu.

Note: Press and hold **No** at any time to exit quickly.

4.2 Calibration Menu [CAL.]

InCal or Span calibration should be performed daily and when the room temperature changes.

InCal [InCAL] calibrates the balance using an internal mass.

Span Calibration [SPAN] uses two weight values: zero and a weight between 50% and 100% of the capacity of the balance.

Linearity calibration [L.F.] uses three weight values zero, 50% of capacity and full capacity. Generally this calibration is not required unless testing shows that the linearity error exceeds the Linearity tolerance in the Specification table. (Not available in InCal models)

Calibration Adjust [CAL ADJ] allows adjustment to the result of the internal calibration by +/- 99 divisions. (InCal models only)

4.3 Setup Menu [SETUP.]

Automatic Zero-Setting [AZSM] – Environmental changes can cause the display to drift. The Automatic Zero-Setting Mechanism (AZSM) is designed to keep the balance set at zero, despite these slight changes. (OFF, SET.5d, SET 1d, SET 2d, SET 5d)

Filter [F.F.F.] – Use the low setting (SET LO) when environmental disturbances are not present. Use the medium setting (SET MED) for normal environments. Use the high setting (SET HI) when vibrations or air currents are present.

Auto Tare [ATARE] – The initial item placed on the balance is assumed to be a container so it is zeroed out. The next item is then weighed. When the pan is cleared the balance resets, waiting for a container. (SET OFF, SET ON)

Grad [ᄒᄒᄒᄒ] – Select the readability displayed. Reducing the readability may be needed for approval. (SET 1d, SET [1]d, SET 10d)

Global Reset [ᄒᄒᄒᄒ ᄒᄒᄒᄒ] – Resets all settings to factory default values. (RESET)

4.4 Mode Menu [ᄒᄒᄒᄒᄒᄒ]

Count Mode [ᄒᄒᄒᄒᄒᄒ] - [SET ON or OFF]

Average Piece Weight (APW) Optimization [ᄒᄒᄒᄒᄒᄒ ᄒᄒᄒᄒ] - (SET ON, SET OFF)

Percent Mode [ᄒᄒᄒᄒᄒᄒᄒ] - (SET ON, SET OFF)

Dynamic Mode [ᄒᄒᄒᄒ] – [SET ON, OFF] – [Auto] – [SET ON, OFF]

Density Mode [ᄒᄒᄒᄒᄒᄒ ᄒᄒᄒᄒ] - [SET ON, OFF] - [Solid, Liquid] – [Water, Other] – [T 20.0C] – [01.00000] – [Sinker] – [010.000 ml]

When [T 20.0C] – [01.00000], [010.000] occur, use **No** to change the number and **Yes** to accept the change.

4.5 Unit Menu [ᄒᄒᄒᄒᄒᄒ]

The Unit menu is used to enable or disable a specific unit. (SET ON, SET OFF) The unit is indicated by a small character next to Unit in the display (g = grams). The default setting is Grams SET ON and all other units SET OFF.

T-Units – When unit [t] displays; press **Yes** to show the T-Unit settings; SET OFF, SET TT (Taiwan Tael), SET TH (Hong Kong Tael), SET TS (Singapore Tael), SET TO (Tola) or SET TI (Tical).

M-Units – When unit [m] is displayed, press **Yes** to show the M-Unit settings; SET OFF, SET MO (Momme) or SET ME (Mesghal).

Custom Unit – Custom Unit (C) is used to create a unit of measure not provided with the balance. The Custom Unit is defined by a factor, a multiplier (E) and a least significant digit (LSD). The balance will use this to convert grams to a custom unit of measure. (Example: 1 gram = 0.257206 Avoirdupois Dram, using a 4100g x 0.01g balance) To create a custom unit, press **Yes** when unit [c] is displayed.

Factor – The Factor (F) is a value from 0.1000000 to 1.999999. When the Factor is displayed, the first digit is flashing. Press **Yes** to accept its value and activate the next digit, or **No** to edit. When editing, press **No** until the desired value appears, then press **Yes** to accept. Repeat until all digits have been accepted. When the Factor flashes on the display, press **Yes** to accept or **No** to re-edit. (Example: F = 0.257206)

Multiplier (E) – The settings are, [E ᄒ] (Fx1), [E ᄒ] (Fx10), [E ᄒ] (Fx100), [E ᄒ] (Fx1000), [E - ᄒ] (F/1000), [E - ᄒ] (F/100), and [E - ᄒ] (F/10). Press **No** to display the next setting, **Yes** to accept. (Example: E = 0).

Note: The multiplier selections are limited when the capacity in grams is exceeded.

LSD – The Least Significant Digit (LSD) is the number of displayed divisions (d) by which the weight is incremented. The values are 1d, 2d, 5d, 10d, 100d or 0.5d. Press **No** to go to the next setting, press **Yes** to accept. (Example LSD = 1d) Note: LSD options are limited if the readability in grams is exceeded.

The example custom unit will display [ᄒ.ᄒᄒ C] when 1g is placed on the pan.

4.6 Print Menu [ᄒᄒᄒᄒᄒᄒ]

Output Stable [ᄒᄒᄒᄒᄒᄒᄒ] – Data will only be sent when the Stable indicator is on. This setting works with manual button pressing or continuous and interval Auto Print. (SET ON, OFF)

Auto Print [ᄒᄒᄒᄒᄒᄒᄒ] – Data will be continuously sent when [ᄒᄒᄒᄒᄒᄒᄒ] is set. Interval [ᄒᄒᄒᄒᄒᄒ] sends data every 1 to 3600 seconds. When Stable [ᄒᄒᄒᄒᄒᄒᄒ] will send data when the balance detects a new stable reading. This can be a weight value only [ᄒᄒᄒᄒᄒᄒ] or it can also include a stable zero [ᄒᄒᄒᄒᄒᄒᄒ]. [ᄒᄒᄒᄒᄒᄒ] disables automatic printing.

Content [ᄒᄒᄒᄒᄒᄒᄒᄒᄒ] – The content in the data transmission can be modified. Each of the following settings can be set on or off. Number Only [ᄒᄒᄒᄒᄒᄒᄒᄒᄒ] will only send the numeric result. Balance ID [ᄒᄒᄒᄒᄒᄒᄒᄒ] will add the Balance serial number for traceability purposes. Reference [ᄒᄒᄒᄒᄒᄒᄒᄒ] will add reference information relevant to the current mode. GLP [ᄒᄒᄒᄒᄒᄒᄒ] will send additional items to allow proper documentation of laboratory results.

Line Format [L nE F0] – Single line format [5 n9L E] will put all the data in one line separating each output with a comma (.). Multi line format [F nL L .] will put each data output on a new line. Multi +4 [F n- 4L F] will add 4 line spaces between each output.

<pre> AAAAAAAAAAAAAAAAAAAAAAAAAAAA User ID: Bal ID: 123456789 Proj ID: Time: Date: / / 120.01 g AAAAAAAAAAAAAAAAAAAAAAAAAAAA </pre>	<ul style="list-style-type: none"> _____ Multi Line Format with 4 line feeds _____ Line Feed-2 _____ Line Feed-3 _____ Line Feed-4 _____ GLP (ON) _____ Balance ID (ON) _____ GLP (ON) _____ GLP (ON) _____ GLP (ON) _____ Result
---	---

4.7 RS232 Menu [L 5232.]

- Baud** [b nB n] – The RS232 baud rate can be set to 600, 1200, 2400, 4800, 9600 and 19200.
- Parity** [P n- .L n] – Parity can be sent to 7 bits-even parity [7 E n E n], 7bits-odd parity [7 o d d], 7bits-no parity [7 n o] or 8bit-no parity [8 n o].
- Handshake** [H n n d 5 n] – Handshake can be set to off [0 F F], X on – X off [o n - o F F], or hardware [H n r d L n n].

4.8 Lock Menu [L L0C.]

When a Lock Menu item is SET ON the indicated menu cannot be changed.
 [L o c E n L] – Calibration, [L o c 5 E L] – Setup, [L o c. F n n o d] – Mode, [L o c. L n n . L] – Unit, [L o c P r L] – Print, [L o c 2 3 2] – RS232.

4.9 Sealing Access to the Balance Settings

The Menu Lock switch prevents changes to the Lock Menu. The switch can be secured using paper seals, wire seals or plastic ties.

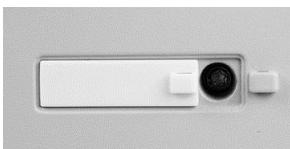

Un-Locked

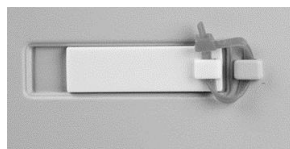

Locked with Plastic Tie

5.0 MAINTENANCE

5.1 Troubleshooting

Symptom	Possible Cause	Remedy
Cannot turn on	No power to balance	Verify connections and voltage.
Poor accuracy	Improper calibration	Perform calibration
	Unstable environment	Move balance to suitable location
Cannot calibrate	Unstable environment	Move the balance to suitable location
	Incorrect calibration masses	Use correct calibration masses
Cannot access mode	Mode not enabled	Enter menu and enable mode
Cannot access unit	Units not enabled	Enter menu and enable units
Err 5	Average Piece Weight too small	Add additional samples
Err 7.0	Time out	
Err 8.1	Pan has load during power on	Remove weight from pan and re-zero.
Err 8.2	Pan was removed prior to power on	Install pan and re-zero.
Err 8.3	Weight on pan exceeds capacity	Remove weight from the pan
Err 8.4	Pan was removed during weighing	Re-install pan
Err 9.5	Factory calibration data corrupted	Contact the authorized dealer
Err 9.8	Factory calibration data corrupted	Perform calibration
Error 53	EEPROM Checksum error	Contact the authorized dealer
REF Err	Reference Weight is too small	Add additional samples
LOWREF	Reference Weight is too low for accurate parts counting or percent weighing.	Add additional samples or continue to weigh with less accurate results.

5.2 Service Information

If the troubleshooting section does not resolve or describe your problem, contact your authorized Ohaus service agent. Please visit our web site, www.ohaus.com to locate the Ohaus office nearest you.

5.3 Accessories

Security device	80850000
Auxiliary Display	80251396
Density Determination Kit	80253884 (0.1mg and 1mg models only)
Printer – Thermal	Contact Ohaus
Printer - Impact	Contact Ohaus
Cable Kit – Thermal Printer	Contact Ohaus
Cable Kit - Impact Printer	Contact Ohaus
Software Winwedge	80850080

6. TECHNICAL DATA

Ambient conditions – The technical data is valid under the following ambient conditions:

Ambient temperature: 10°C to 30°C

Relative humidity: 15 % to 80 % at 31°C non-condensing, decreasing linearly to 50% at 40°C

Height above sea level: Up to 2000 m

Operability is assured at ambient temperatures between 5°C and 40°C

Power – AC adapter, Balance power input 8-14.5 VAC, 50/60Hz 4VA or 8-20 VDC, 4W

Protection – Protected against dust and water, Pollution degree: 2, Installation category: Class II

6.1 Drawings

0.01g and 0.1g Models

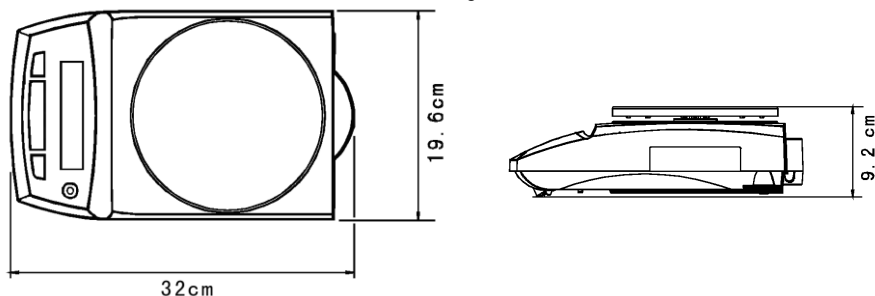

0.0001g and 0.001g Models

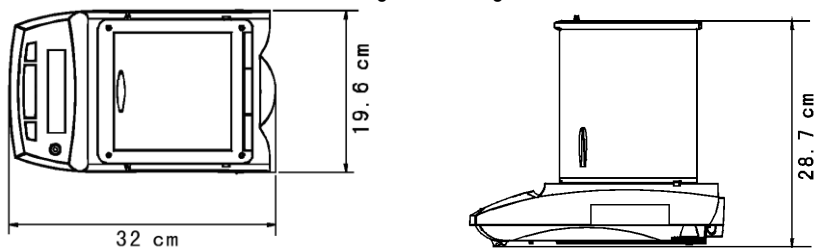

6.2 Specifications

Excal Model	PA84	PA124	PA224	PA163	PA323	PA523
Incal Model	PA84C	PA124C	PA224C	PA163C	PA323C	PA523C
Capacity (g)	85	120	220	160	320	520
Readability d	0.1mg			1mg		
Repeatability (Std Dev)	0.1mg			1mg		
Linearity	0.2mg		0.3mg	2mg		
Tare Range	To capacity by subtraction					
Stabilization Time	3 seconds					
Cal Weight-Span	50,80g	50,100g	100,200g	100,150g	200g,300g	200,500g
Cal Weight-Linearity	20/60g	50/100g	100/200g	100/150g	150/300g	200/500g
Pan Size	3.54 in / 9 cm diameter			4.72 in / 12 cm diameter		
Net Weight	10.1 lb / 4.6kg (11.2lb/5.2kg for Incal Model)					

Excal Model	PA1602	PA2202	PA3202	PA4202	PA2201	PA4201
Incal Model	PA1602C	PA2202C	PA3202C	PA4202C	PA2201C	PA4201C
Capacity (g)	1600	2200	3200	4200	2200	4200
Readability d	10mg				100mg	
Repeatability (Std Dev)	10mg				100mg	
Linearity	20mg				100mg	
Tare Range	To capacity by subtraction					
Stabilization Time	3 seconds					
Cal Weight-Span	1,1.5kg	1,2kg	2,3kg	2,4kg	1,2kg	2,4kg
Cal Weight-Linearity	1/1.5kg	1/2kg	1.5/3kg	2/4kg	1/2kg	2/kg
Pan Size	7.1 in / 18 cm diameter					
Net Weight	10 lb / 4.5 kg(11.1 lb / 5.1 kg for Incal Model)					

6.3 Communication

6.3.1 Commands

The RS232 Interface allows a computer to control the balance as well as receiving data such as the displayed weight. The balance will return "ES" for invalid commands.

Command	Function
IP	Immediate Print of displayed weight.
P	Print displayed weight (uses Stable ON/OFF menu settings).
CP	Continuous Print.
xP	Interval Print x = Print Interval (1-3600 sec)
T	Same as pressing Zero Key.
ON	Turns balance ON.
OFF	Turns balance OFF.
PSN	Show Serial Number.
PV	Version: Print product name, software revision and LFT ON (if LFT is set ON).
PU	Print current mode/unit
x#	Set PC ref wt (x) in grams
P#	Print PC ref wt
x%	Set % ref wt (x) in grams
P%	Print % ref wt

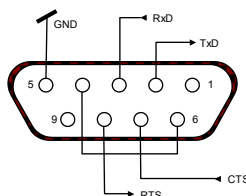

6.3.2 RS232 (DB9) Pin Connections

- Pin 2: Balance transmit line (TxD)
- Pin 3: Balance receive line (Rx/D)
- Pin 5: Ground signal (GND)
- Pin 7: Clear to send (hardware handshake) (CTS)
- Pin 8: Request to send (hardware handshake) (RTS)



6.4 Compliance

Compliance to the following standards is indicated by the corresponding mark on the product.

Mark	Standard
	This product conforms to the EMC Directive 2004/108/EC, the Low Voltage Directive 2006/95/EC and the Non-Automatic Weighing Directive 2009/23/EC. The complete Declaration of Conformity is available from Ohaus Corporation.
	AS/NZS4251.1; AS/NZS4252.1
	CAN/CSA-C22.2 No. 1010.1-92; UL Std. No. 3101-1

FCC Note

This equipment has been tested and found to comply with the limits for a Class A digital device, pursuant to Part 15 of the FCC Rules. These limits are designed to provide reasonable protection against harmful interference when the equipment is operated in a commercial environment. This equipment generates, uses, and can radiate radio frequency energy and, if not installed and used in accordance with the instruction manual, may cause harmful interference to radio communications. Operation of this equipment in a residential area is likely to cause harmful interference in which case the user will be required to correct the interference at his own expense.

Industry Canada Note

This Class A digital apparatus complies with Canadian ICES-003.

ISO 9001 Registration

ISO 9001 Registration In 1994, Ohaus Corporation, USA, was awarded a certificate of registration to ISO 9001 by Bureau Veritus Quality International (BVQI), confirming that the Ohaus quality management system is compliant with the ISO 9001 standard's requirements. On June 21, 2012, Ohaus Corporation, USA, was re-registered to the ISO 9001:2008 standard.

LIMITED WARRANTY

Ohaus products are warranted against defects in materials and workmanship from the date of delivery through the duration of the warranty period. During the warranty period Ohaus will repair, or, at its option, replace any component(s) that proves to be defective at no charge, provided that the product is returned, freight prepaid, to Ohaus.

This warranty does not apply if the product has been damaged by accident or misuse, exposed to radioactive or corrosive materials, has foreign material penetrating to the inside of the product, or as a result of service or modification by other than Ohaus. In lieu of a properly returned warranty registration card, the warranty period shall begin on the date of shipment to the authorized dealer. No other express or implied warranty is given by Ohaus Corporation. Ohaus Corporation shall not be liable for any consequential damages.

As warranty legislation differs from state to state and country to country, please contact Ohaus or your local Ohaus dealer for further details.

Visit www.balances.com to see the full line of Ohaus Balances

Visit www.scaleman.com to see more Ohaus Digital Scale